

Revision Notes.		
Checked By: -	Approved By: -	Date Released: -

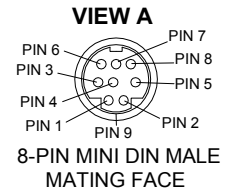

PIN #	DESCRIPTION
1	+5VDC
2	GND
3	DATA
4	CLOCK
5	DATA
6	GND
7	AUDIO
8	VIDEO
9	GND/SHIELD

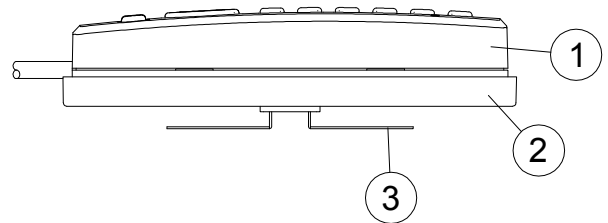
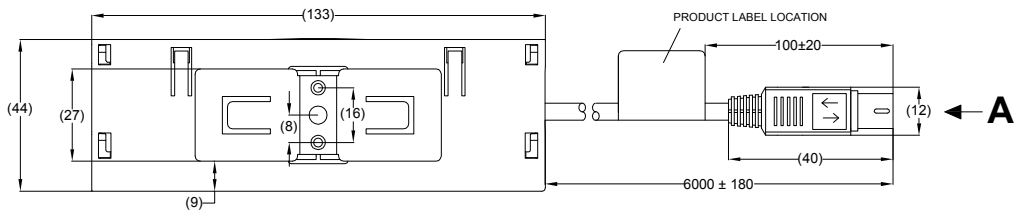
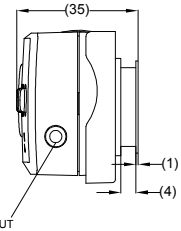
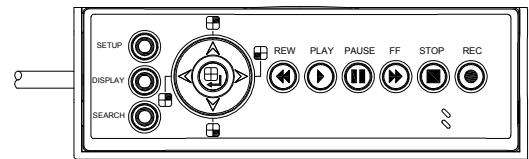
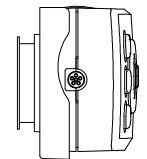
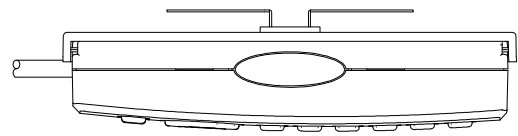
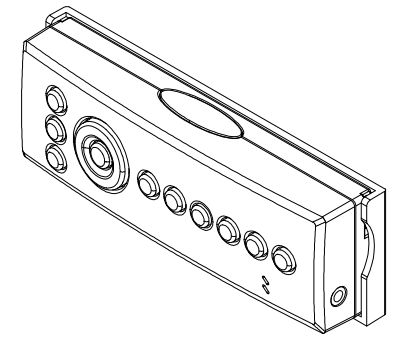

ITEM	DESCRIPTION
①	REMOTE CONTROL UNIT
②	MOUNTING DOCK
③	MOUNTING BRACKET

- NOTES:
- FOR GIFTBOX LABEL REFER TO LATEST REVISION OF DRAWING: BE-002009-XX-12.
 - FOR PRODUCT LABEL REFER TO LATEST REVISION OF DRAWING: BE-002008-XX-12.
 - TO BE SUPPLIED WITH STICKY MOUNTING PADS AND 3.5MM JACK TO RCA ADAPTER CABLE.
 - TO BE SUPPLIED IN UNBRANDED BOX SIZE: 280MMx120MMx65MM.
 - FOR USE WITH MDR-304A SERIES ONLY, NOT BACKWARDS COMPATIBLE WITH ORIGINAL MDR-300 SERIES.

PROPRIETARY NOTICE
 THIS DESIGN AND TECHNICAL INFORMATION APPEARING ON THIS DRAWING IS THE PROPERTY OF BRIGADE ELECTRONICS, AND IS DISCLOSED IN CONFIDENCE. IT IS NOT TO BE COPIED, REPRODUCED, REVEALED TO OR EXPROPRIATED BY OTHERS, EITHER IN WHOLE OR IN PART WITHOUT THE EXPRESS WRITTEN CONSENT OF BRIGADE ELECTRONICS.



Assembly Pl Approval J.Shih - 03/07/12	Approved by S.MATTHEWS	Checked by M.BUTLER	Released 03/07/12	Drawn by J.NEWMAN
Angle of Projection 	Units mm	Scale N/A	Status RELEASED	Assembly Ref RC-300-060
Third Angle	Stock Code 2803A	BE-001963-00-12		